

VIMBLE 2

3-Axis Stabilized Handheld Gimbal for Smartphone

Guilin Feiyu Technology Incorporated Company

User Manual EN V 1.2

Product overview

1. Structure

Smartphone shown in illustrations is for reference only

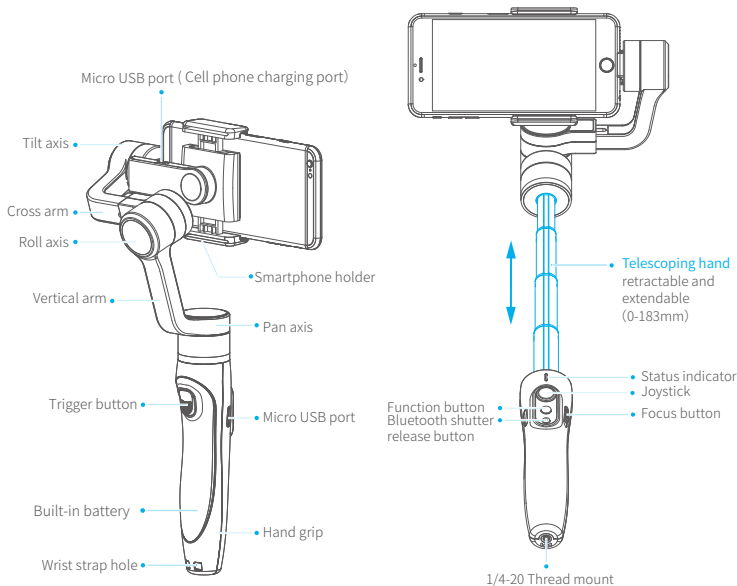

2. Included items

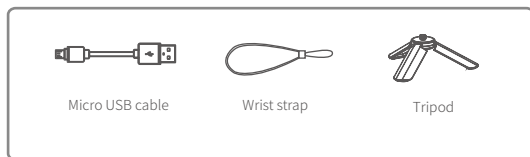

Operation guide

1. Gimbal charging

■ Please fully charge the battery before powering on the gimbal for the first time

Charging with Micro USB cable Indicator is red in charging status, and becomes green when battery full.

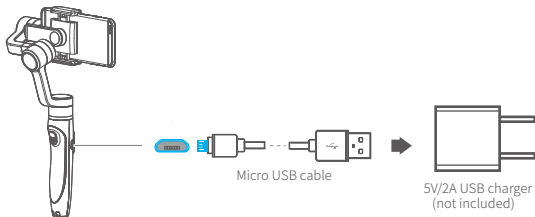

- ⚠ (1) Please install the smartphone before powering on the gimbal.
(2) When not in use, turn off the gimbal and then remove the smartphone.

2. Smartphone charging

Charge the phone via cable and choose the corresponding cable according to charging port.

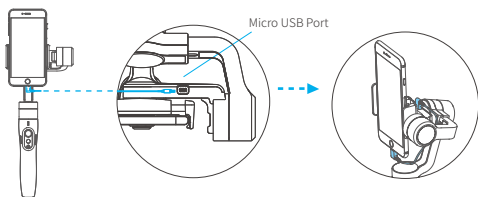

3. Insert smartphone

- It's recommended to remove your smartphone protective case.
■ Smartphone holder width range : 57-84mm.

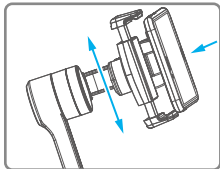

Place smartphone in holder so that the phone is snug against the back of the holder.

- If the smartphone is unbalanced after being mounted, refer to the following steps to make adjustment.

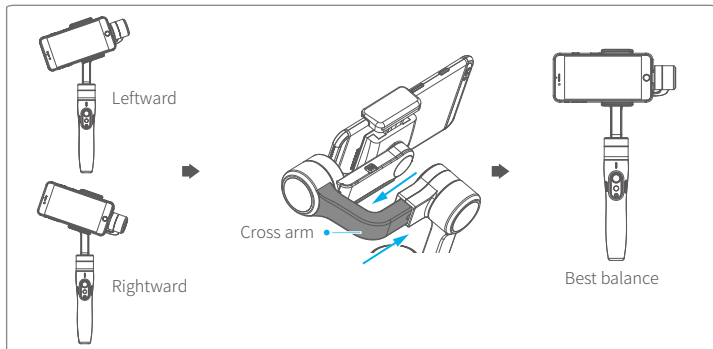

(1) If smartphone tilts to the left, pull cross arm out to the right until phone is horizontal.

(2) If smartphone tilts to the right, push cross arm in to the left until phone is horizontal.

4. Smartphone rotation

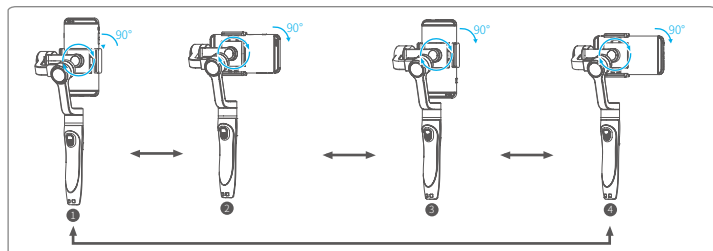

Vertical Shooting

It is effective only when it is set right from the pitch axis, please see the graph

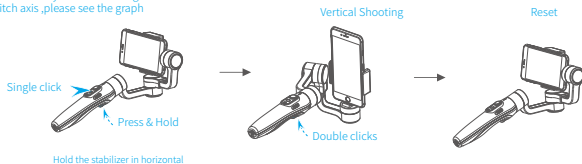

Tip:



Load weight:
100~200g

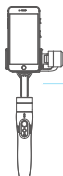

Load weight:
 $\leq 130g$

5. Power on / off

- Make sure the smartphone is secure before powering on the gimbal.
- When battery is low, the status indicator will blink red three times every 5 seconds. Please charge gimbal.

Power on: press and hold the function button until the status indicator turns green and gimbal beeps.

Power off: press and hold the function button until the status indicator changes from a flashing red to a solid red light and gimbal beeps.

Functions modes

Operation method

Status Indicator Explanation

- The current mode of the gimbal can be identified by the indicator status.

Indicator status	Mode / Status
Blue light flashes once	Pan mode
Blue light flashes twice	Follow mode
Constant Blue light	Lock mode / gimbal initializing / motion control mode
Blue light keeps flashing	Initialization failure/ malfunction
Red light flashes three times	Low power
Red light keeps flashing	Gimbal powering off

Bluetooth shutter release button

By connecting bluetooth or Feiyu ON App, you can operation as follow

Button	Mode / Indicator status
Single click	Photo / Status indicator flashes green once
Press & Hold	Video / Status indicator remains solid green during recording

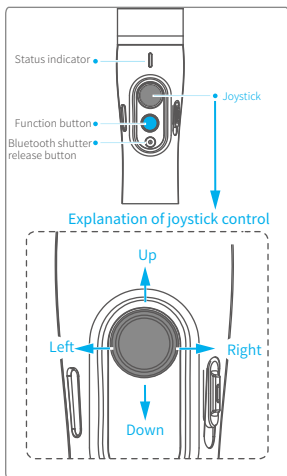

Troubleshooting: if the gimbal fails to connect to the Feiyu ON App, power off the gimbal. Press and hold both the bluetooth shutter release button and the function button to reset the bluetooth connection.

- The firmware upgrade may occur manual operation function and the actual product features do not match. Please get the latest version manual on the official website.

Function button	Function	Explanation
Single click	Panning Mode / Lock Mode	Single tap to switch between panning mode and lock mode
Double clicks	Follow mode	In the follow mode, the joystick is pushed to the left / right , to push and control the angle is -30° ~ + 30°, push it up ward or down ward to realize pitching control. Under follow mode, single click the function button and enter into panning mode
Triple clicks	Switching camera lens	It needs to be used with Vicool APP
Four clicks	Motion Control mode	Both the panning and tilting directions can be rotated
Five clicks	Initialization	After the initialization succeeds or fails, you can click the function button to wake up the gimbal
Trigger button	Function	Explanation
Press & Hold	Temporary Lock	In the pan mode or follow mode, holding the trigger button temporarily locks panning and tilting until released
Double clicks	Reset to default	Centers the camera away from the user on all 3 axes (pan, tilt and roll) and switches back to the default pan mode
Focusing button	Function	Explanation
Sliding up-down	Adjust focus	Adjust field-of-view (FOV)(It needs to be used with Feiyu ON APP)

Modes

Panning mode (Default mode)—The rolling and tilting direction are fixed, and the smartphone moves according to the hand movement direction of the user.

Follow mode—The rolling direction is fixed, and the smartphone moves according to the hand movement direction of the user.

Lock mode—The orientation of the smartphone is fixed.

Reset—Return to pan mode, all to return to default.

Manual Lock

Smartphone can be manually positioned while in lock mode , follow mode or pan mode. Both the pan and tilt can be manually set.

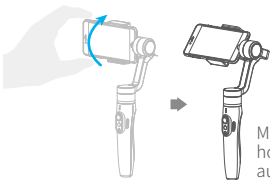

Manually move smartphone to desired position, and hold for half a second. New tilt and/or pan positions are automatically saved.

Motion Control Mode

The gimbal can easily create constant speed moves by using the motion control mode. This mode can be used for recording both regular video and timelapse photography. For best results, attach gimbal to the FeiyuTech tripod, or other tripod, to keep it completely still.

1. Set motion speed in Feiyu ON App

To set the motion speed, connect to the Feiyu ON App and select desired speed from the motion control option in the settings menu.

Motion control speed reference table

Vimble2 Rotation speed													
12 seconds / turn	18 seconds / turn	24 seconds / turn	30 seconds / turn	1 minute / turn	2 minutes / turn	4 minutes / turn	8 minutes / turn	15 minutes / turn	30 minutes / turn	1 hour / turn (default)	4 hours / turn	8 hours / turn	

2. Enter motion control mode by clicking the function button 4 times

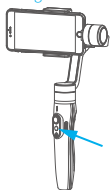

4. Set rotation end position

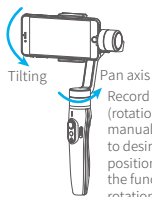

Record the second position (rotation end position) by manually moving smartphone to desired position. Hold in position for half a second. Click the function button to record rotation end position.

3. Set rotation start position

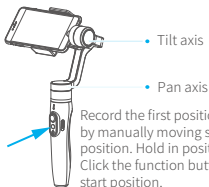

Record the first position (rotation start position) by manually moving smartphone to desired position. Hold in position for half a second. Click the function button to record rotation start position.

5. The gimbal is motion control from rotation start position to rotation end position

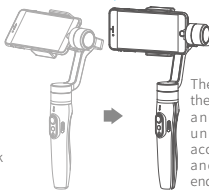

The stabilizer automatically returns to the starting position, and the pitch axis and the pan axis start to rotate uniformly to the ending position according to the set rotation speed, and enter the follow mode at the ending position.

Exit operations:

1. After auto-rotation is finish, the stabilizer automatically exits auto-rotation mode and enters the follow mode.
2. Enter the motion control mode or motion control setting, double click the trigger button to exit the motion control mode and reset the gimbal.

Gimbal Initialization

Initialize gimbal when:

- (1) Smartphone fails to remain level.
- (2) Gimbal has no been used for a long period of time.
- (3) Gimbal is used in extreme temperature variations.

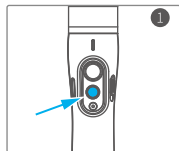

Click the function button five times. The motors will stop working. Status indicator turns solid blue.

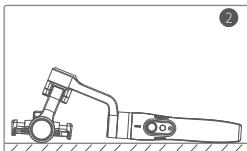

Place the gimbal on a flat, horizontal surface. The gimbal will automatically initialize after a few seconds detecting no movement. The blue light will flash three times to indicate end of initialization.

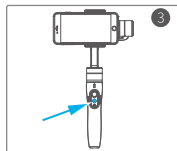

After the initialization is successful, click the function button to wake up.

Note: if the initialization is not successful, click the function button to wake up. restart initialization process.

Download App and firmware upgrade

1. Download App



Feiyu ON



Please download Feiyu ON at your smartphone app store or scan the QR code.

* Requires iOS 9.0 or later, Android 6.0 or later.



iOS Version



Android Version

2. Firmware upgrade

Upgrade the firmware through the Feiyu ON App.

- (1) Click the icon
- (2) Select upgrade type.
- (3) Follow the prompts to upgrade the firmware.

Upgrade type introductions:

Gimbal update: Repair / update or newly add gimbal control / function / parameter and etc.

Keyboard update: Repair / update or newly add button/interaction functions, repair few bugs and etc.

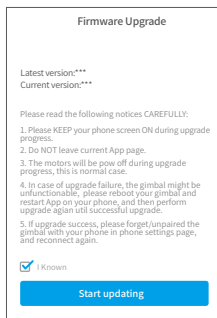

Technical Specifications

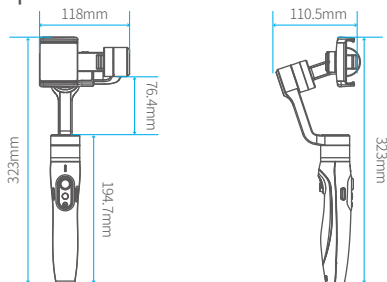

Max. tilting range	320°	Load weight	210g
Max. rolling range	320°		
Max. panning range	320°		
Operation time	operation time in motion shooting: around 5 hours; operation time in normal shooting: around 10 hours		
Adaption phone	smartphones (mobile phone width range 57-84mm)		
Weight	428g (not including smartphone)		

DISCLAIMER

Any user for illegal purpose prohibited. Users are responsible for use products.

The Company assumes no liability for any risks related to or resulting from the debug and use of this product (including direct, indirect or third-party losses).

For any unknown sources of using, we will not be at any services.

Updating and changes of product firmware and program me may cause changes in function descriptions in this user manual, please read the instructions carefully before upgrading the firmware and use the corresponding user manual.

You can get the latest user manual from the official website: www.feiyu-tech.com

FeiyuTech reserves the right to amend this manual and the terms and conditions of use the gimbal at any time.

Attention

- Please correctly assemble the gimbal in accordance with the diagram.
- Please install the smartphone before turning on the gimbal.
- When the gimbal is not in use or placed on the table, please ensure it is powered off.

Guilin Feiyu Technology Incorporated Company

Website: www.feiyu-tech.com

E-mail: service@feiyu-tech.com

Tel: +86(0)773 2320865

Due to software and hardware improvements, your actual product might differ from the descriptions and pictures in this user manual. You can get the latest user manual from the official website.

For more information, please visit our official website

